

SMART Board® 800 series interactive whiteboards

USER'S GUIDE

FCC warning

This equipment has been tested and found to comply with the limits for a Class A digital device, pursuant to Part 15 of the FCC Rules. These limits are designed to provide reasonable protection against harmful interference when the equipment is operated in a commercial environment. This equipment generates, uses and can radiate radio frequency energy and, if not installed and used in accordance with the manufacturer's instructions, may cause harmful interference to radio communications. Operation of this equipment in a residential area is likely to cause harmful interference in which case the user will be required to correct the interference at his own expense.

Trademark notice

SMART Board, DVIT, SMART Notebook, SMART Meeting Pro, SMART Ink, smarttech, the SMART logo and all SMART taglines are trademarks or registered trademarks of SMART Technologies ULC in the U.S. and/or other countries. Microsoft, Excel, PowerPoint, Windows and Windows Vista are either registered trademarks or trademarks of Microsoft Corporation in the U.S. and/or other countries. Mac, OS X and Finder are registered trademarks of Apple, Inc., registered in the U.S. and other countries. All other third-party product and company names may be trademarks of their respective owners.

Copyright notice

© 2011–2018. All rights reserved. No part of this publication may be reproduced, transmitted, transcribed, stored in a retrieval system or translated into any language in any form by any means without the prior written consent of SMART Technologies ULC. Information in this manual is subject to change without notice and does not represent a commitment on the part of SMART.

Portions of the software that ships with this product are copyrighted by Intel Corporation.

This product and/or use thereof covered by one or more of the following U.S. patents: smarttech.com/patents. Other patents pending.

08/2018

Important information

Before you install and use the SMART Board® 800 series interactive whiteboard, read and understand the safety warnings and precautions in this guide. These safety warnings and precautions describe the safe and correct operation of the interactive whiteboard and its accessories, helping you to prevent injuries and equipment damage. Ensure that the interactive whiteboard system is always being used correctly.

NOTE

In this document, the term “interactive whiteboard” refers to the interactive whiteboard and its accessories and options.

Safety warnings and cautions

WARNING

- Ensure that any cables extending across the floor to the SMART product are properly fastened together and marked to avoid a trip hazard.
- To reduce the risk of fire or electric shock, do not expose the SMART product to rain or moisture.
- Refer to the safety warnings and precautions published by the projector manufacturer. Do not stare (or allow children to stare) directly into the projector’s beam of light.
- Do not touch (or allow children to touch) the projector. It can become extremely hot during normal operation.
- Do not stand (or allow children to stand) on a chair to touch the surface of the SMART product. Instead, safely fix the product at the appropriate height on a wall or use a SMART height-adjustable floor stand.
- Do not climb (or allow children to climb) on a wall- or stand-supported SMART Board interactive whiteboard.



IMPORTANT INFORMATION

- Safely mounting the interactive whiteboard requires two people because it is too heavy for one person to safely maneuver. When you and your assistant lift the interactive whiteboard, support its weight at the bottom, avoiding the corner cameras, and balance the top with your other hands.
- The weight of the interactive whiteboard is approximately 52 lb. (23.7 kg) for the SMART Board 880 interactive whiteboard and 61 lb. (27.5 kg) for the SMART Board 885 interactive whiteboard. Check your local building codes to ensure that the wall can support this weight, and use appropriate mounting hardware for the type of wall.
- To prevent injury or product and property damage, use only the mounting hardware supplied with the SMART Board 800 series interactive whiteboard when you install the product on drywall. The mounting hardware provided with other interactive whiteboards may not be strong enough to support the weight of a SMART Board 800 series interactive whiteboard.
- Use two wall-mounting brackets to install SMART Board interactive whiteboards with a diagonal width of 87" (221 cm).
- For operating safety and to prevent damage to the interactive whiteboard, connect its USB connector, or SMART connection extenders, only to a computer that has a USB compliant interface and that bears the USB logo. In addition, the USB source computer must be compliant with CSA/UL/EN 60950 and bear the CE mark and CSA and/or UL mark(s) for CSA/UL 60950.
- To prevent injury or product damage as a result of tipping, mount the interactive whiteboard only on a floor stand that is certified for use with SMART Board 800 series interactive whiteboards, such as the SMART FS670 Mobile Floor Stand or SMART HAWM FS-UX Mobile Height-Adjustable Floor Stand. Do not modify the interactive whiteboard or the floor stand to make them compatible.
- Move a floor stand-supported SMART Board interactive whiteboard with care. Sudden stops, excessive force and uneven surfaces may cause the product to overturn.

CAUTION

- If you're replacing a SMART Board 500 or 600 series interactive whiteboard with the heavier SMART Board 800 series interactive whiteboard on drywall, you must remove the wall-mount bracket and mounting hardware, and then install all the mounting hardware and brackets supplied with the SMART Board 800 series interactive whiteboard instead.
- If you need to lean your interactive whiteboard against a wall, make sure that it remains in an upright position, resting on its pen tray brackets, which are designed to sustain the interactive whiteboard's weight. Do not rest the interactive whiteboard on its side, on the top of its frame or on the corners of the frame where the cameras are located.

IMPORTANT INFORMATION

- Do not add any extra weight or pressure to a wall-mounted interactive whiteboard or its pen tray. SMART designed the brackets to support only the weight of the interactive whiteboard and its accessories during normal use.
- There are no user-serviceable parts inside the pen tray.
- When transporting the SMART Board interactive whiteboard, repack it with the original packaging. This packaging was designed to provide the best possible protection against shock and vibration.
- Do not use compressed air to clean the cameras.
- Do not allow cleaner to flow onto the infrared (IR) reflective material at the edges of the interactive whiteboard frame, or into the pen tray slots.
- Do not set up and use the interactive whiteboard in an area with excessive levels of dust, humidity or smoke.
- If the SMART Board interactive whiteboard requires replacement parts, make sure that the service technician uses replacement parts specified by SMART Technologies.

Other precautions

If you own a SMART product other than a SMART Board 800 series interactive whiteboard, refer to the installation manual for that product for relevant warnings and maintenance instructions.

Contents

Important information	i
Safety warnings and cautions	i
Other precautions	iii
Chapter 1: About the SMART Board 800 series interactive whiteboard	1
Identifying the components of the SMART Board 800 series interactive whiteboard	2
Highlights	2
Understanding how the SMART Board interactive whiteboard works	4
Included parts and accessories	5
Optional accessories	6
Chapter 2: Installing and securing the SMART Board interactive whiteboard	7
Environmental requirements	7
Installing the SMART Board interactive whiteboard	8
Chapter 3: Setting up the interactive whiteboard	13
Connecting the interactive whiteboard to the computer	13
Installing SMART Product Drivers	14
Configuring the computer settings	15
Calibrating the interactive whiteboard	16
Orienting the interactive whiteboard	17
Connecting a guest laptop	19
Chapter 4: Using and maintaining the interactive whiteboard	21
Getting started	22
Using the pen tray	26
Using Ink Aware	27
Writing, selecting and erasing using object awareness	27
Using gestures	28
Tips for trouble-free performance	35
Chapter 5: Troubleshooting the interactive whiteboard	39
Updating SMART software	39
Adjusting the projected image	40
Resetting the interactive whiteboard	40
Using the Connection Wizard	41
Starting the troubleshooting process	42
Troubleshooting using the Ready light	47
Troubleshooting using SMART Board diagnostics	53

CONTENTS

Finding more information	55
Contacting SMART Support	56
Transporting the interactive whiteboard	57
Removing the pen tray	57
Appendix A: Hardware environmental compliance	59
Waste Electrical and Electronic Equipment and Battery regulations (WEEE and Battery Directives)	59
More information	59
Index	61

Chapter 1

About the SMART Board 800 series interactive whiteboard

Identifying the components of the SMART Board 800 series interactive whiteboard	2
Highlights	2
Software	2
Dual sketch capabilities	3
SMART Ink	3
Touch and gestures	3
Pen tray	3
Durable surface and dry erase	3
Wall-mount bracket	3
Cables	3
Security cable lock	3
Understanding how the SMART Board interactive whiteboard works	4
Other components	4
Included parts and accessories	5
Pens	5
Eraser	5
Wall-mounting kit	5
USB cable	5
Extended Control Panel	5
Power supply	5
Optional accessories	6

The SMART Board 800 series interactive whiteboard is the most advanced and intuitive touch sensitive, front projection interactive whiteboard in the world, featuring SMART's proprietary DVIT® (Digital Vision Touch) technology. Its modular and expandable hardware and software architecture enables you to do everything you can do at your computer—open and close applications, meet with others, create or edit documents, visit websites, play and manipulate video clips and more—just by touching the interactive surface.

When you use SMART software, you can also write over any Ink Aware application in digital ink using a pen tray pen or your finger, and then save these notes for future reference and distribution.

Identifying the components of the SMART Board 800 series interactive whiteboard

Use the following illustration to familiarize yourself with the parts of the interactive whiteboard.

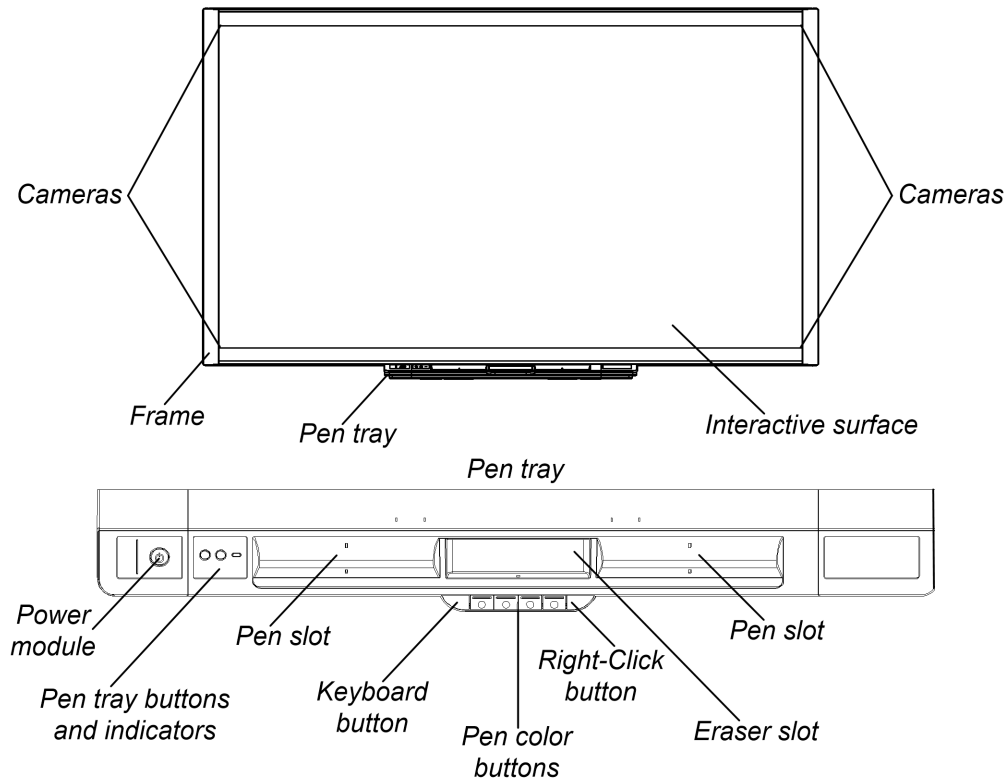

NOTE

The illustration above shows the pen tray for the SMART Board 880 and 885 interactive whiteboards. The 880E and 885E models include the Extended Control Panel described in *Using the Extended Control Panel (SB880E and SB885E only)* on page 24.

Highlights

Software

To use all the interactive whiteboard's features, ensure that you have the latest version of SMART software and SMART Product Drivers installed on your computer. You can download the latest software from smarttech.com/downloads.

Dual sketch capabilities

Two people can each pick up a pen and draw on the interactive surface at the same time, providing a higher degree of interactivity.

SMART Ink

The SMART Ink™ feature smoothes out the appearance of the digital ink, which improves the legibility of your handwriting as you write over applications, websites and videos. The ink becomes an object that you can move and manipulate.

Touch and gestures

You can perform mouse functions with your finger, and write and erase digital ink with a pen tray pen or the eraser. The object awareness feature enables you to pick up a pen, and then write, select or erase without replacing the pen.

Pen tray

The SMART Board 800 series interactive whiteboard features a modular pen tray with an intuitive new design. As well as two pens and an eraser, pen tray buttons activate the pen's color, the on-screen keyboard, right-click, Orientation and Help functions.

Durable surface and dry erase

The hard-coated surface is scratch resistant, optimized for projection, compatible with dry-erase markers and easily cleaned.

Wall-mount bracket

Wall mount brackets enable you to install the SMART Board interactive whiteboard simply and securely.

Cables

Connect the SMART Board interactive whiteboard to your computer with the included, standard USB cable, and to a wall outlet with the included power supply and cords.

Security cable lock

Lock the interactive whiteboard with a security cable (not included) to help safeguard it from theft.

Understanding how the SMART Board interactive whiteboard works

The interactive whiteboard functions as an input device for a computer, just like a mouse, enabling you to work in any application on the computer from the interactive whiteboard.

When you touch the interactive whiteboard's surface, the four cameras located in the interactive whiteboard's corners detect the contact's horizontal and vertical (or x,y) coordinates. The computer interprets these coordinates and moves the pointer to the corresponding location on the interactive whiteboard's surface.

Other components

Using the interactive whiteboard requires two additional components: a computer and a digital projector.

These components work together as follows:

- The computer runs an application and sends the image to the projector.
- The projector casts the image onto the interactive whiteboard.
- The interactive whiteboard acts both as your computer's monitor and its input devices, that is, its mouse and keyboard, enabling you to control any application by touching the interactive surface.

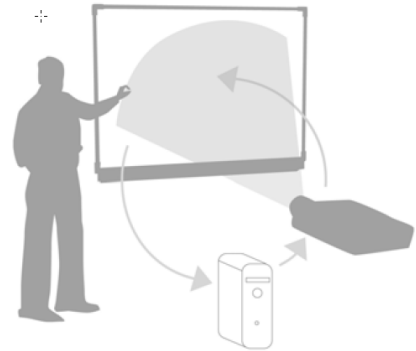

When you install SMART Product Drivers on the computer, the touch of your finger on the interactive surface becomes a mouse click, enabling you to control the computer from the interactive whiteboard. When you use a pen from the pen tray, the system detects which tool you're using. SMART Product Drivers then interacts with the computer's mouse driver to change the pointer to a colored pen, enabling you to write in digital ink on the desktop or any open application. When you use the eraser, you can erase the digital ink. You can even use your finger on the interactive whiteboard's surface without returning the pen tray tools—automatic object awareness determines the tool you're using on the interactive surface. You can also save your notes to a .notebook file, or directly into any Ink Aware application.

Included parts and accessories

The SMART Board 800 series interactive whiteboard includes the following accessories.

Pens

There are two pens included with the interactive whiteboard. Pick up a pen and press one of the four color buttons on the pen tray (black, red, green or blue) to change the color of digital ink you write with on the interactive whiteboard.



Eraser

The eraser is rectangular like a traditional chalkboard eraser.

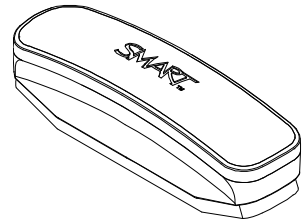

Wall-mounting kit

The 32" (81.3 cm) wall-mount bracket comes with five screws and toggle bolts, enabling you to wall-mount the interactive whiteboard simply and securely. SMART Board 885 interactive whiteboards come with two wall-mounting kits.

USB cable

A 16' 5" (5 m) USB cable enables you to connect your SMART Board 800 series interactive whiteboard to a USB receptacle on your computer.

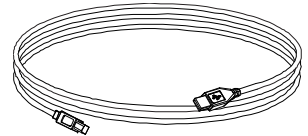

Extended Control Panel

(SB880E AND SB885E ONLY)

The projector system ECP attaches to the interactive whiteboard pen tray. The ECP features controls for power, source selection and volume adjustment, as well as a USB A receptacle for USB drives.

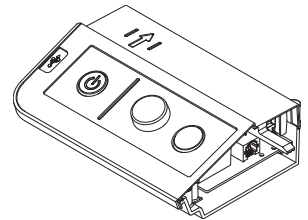

Power supply

The SMART Board 800 series interactive whiteboard receives power from a wall outlet through the included country-specific power supply and cables.

Optional accessories

You can add a variety of optional accessories to the SMART Board 800 series interactive whiteboard to best meet your specific needs.

You can purchase these items when you order an interactive whiteboard, or later from your authorized SMART reseller ([smarttech.com/us/Where](https://www.smarttech.com/us/Where)). For more information about accessories, go to [smarttech.com/accessories](https://www.smarttech.com/accessories).

Chapter 2

Installing and securing the SMART Board interactive whiteboard

Environmental requirements	7
Installing the SMART Board interactive whiteboard	8
Installation tips	9
Replacing an existing interactive whiteboard on drywall	9
Securing the pen tray to the interactive whiteboard	10
Securing the pen tray to the brackets	11

Environmental requirements

Before installing the interactive whiteboard, review the following environmental requirements.

Environmental requirement	Parameter
Operating temperature	41°F to 95°F (5°C to 35°C)
Storage temperature	-40°F to 120°F (-40°C to 50°C)
Humidity	5% to 80% relative humidity, non-condensing
Water and fluid resistance	<ul style="list-style-type: none">• Intended for indoor use only. Doesn't meet any salt-spray or water ingress requirements.• Don't pour or spray liquids directly onto the interactive whiteboard or any of its sub-components. These liquids might get into areas where they could damage sensitive electronic components. Refer to <i>Keeping the writing surface clean</i> on page 37 for detailed instructions on cleaning the interactive whiteboard.

Environmental requirement	Parameter
Dust	<ul style="list-style-type: none"> Moderate dust. Intended for use in office and classroom environments. Not for industrial use where heavy dust and pollutants can cause malfunctions or impaired operation. Designed for pollution degree 1 (P1) as per EN61558-1, which is defined as “No pollution or only dry non-conductive pollution.”
Conducted and radiated emissions	EN55022/CISPR 22, Class A

Installing the SMART Board interactive whiteboard

Follow the procedure outlined in the installation document included in the interactive whiteboard’s box to install the interactive whiteboard. If you purchased a floor stand, wall-mount or an interactive whiteboard system that includes a projector or other components, refer to the installation documents included with these components. The optimal mounting height is 77" (196 cm) from the floor to the center of the installation brackets. However, consider the general height of your user community when you choose a location for wall-mounting the interactive whiteboard. If you mount the interactive whiteboard too low, it might force tall people to bend over uncomfortably. If it’s too high, other people might need to reach up too far. Also remember to leave enough room on either side of the interactive whiteboard so that you can stand beside it.



WARNING

- Safely mounting the interactive whiteboard requires two people. It is too heavy for one person to safely maneuver. When you and your assistant lift the interactive whiteboard, support its weight at the bottom, avoiding the corner cameras, and balance the top with your other hands.
- The weight of the interactive whiteboard is approximately 52 lb. (23.7 kg) for the 880 model and 61 lb. (27.5 kg) for the 885 model. Check your local building codes to ensure that the wall can support this weight, and use appropriate mounting hardware for the wall type.



CAUTION

- If you need to lean the interactive whiteboard against a wall before you mount it, make sure it remains in an upright position, resting on the pen tray brackets, which can sustain the weight of the interactive whiteboard.

- Do not rest the interactive whiteboard on its side or on the top of the frame, or on the corners where the cameras are located.

Installation tips

- Ensure the bottom of the pen tray is unobstructed at all times, because you will need to access it if the interactive whiteboard requires service.
- Install the interactive whiteboard on a flat, plumb wall.
- If you're installing the interactive whiteboard on drywall, use all the toggle bolts supplied. Because one of the mounting bracket holes aligns with a wall stud, use appropriate hardware in that hole instead of a toggle bolt.
- Ensure that the power supply cable is connected to the correct receptacle in the pen tray, as shown below.

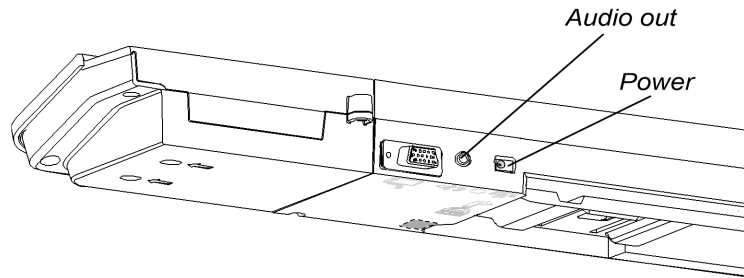

Replacing an existing interactive whiteboard on drywall

If you're replacing a SMART Board 500 or 600 series interactive whiteboard with the heavier SMART Board 800 series on drywall, you must remove the wall-mount bracket and mounting hardware, and then install all the mounting hardware and brackets supplied with the SMART Board 800 series interactive whiteboard instead.

CAUTION

To help ensure that the interactive whiteboard is mounted correctly, make sure the color of the wall-mount hanger on the back of the interactive whiteboard and the color of the wall-mount bracket are the same.

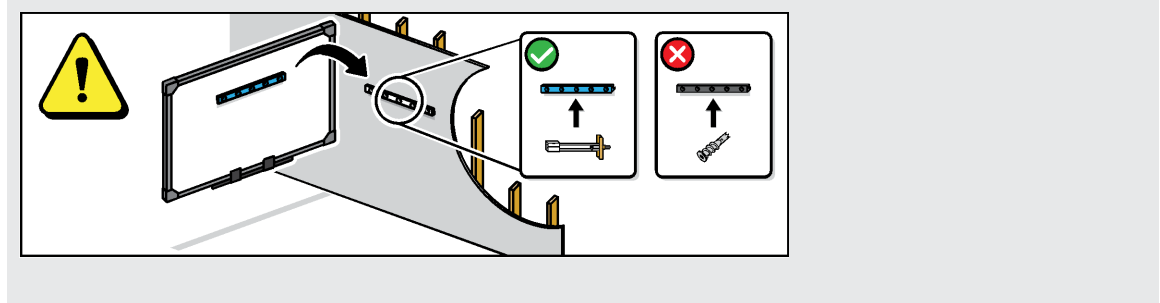

Securing the pen tray to the interactive whiteboard

Because the pen tray is detachable, you might want to safeguard it—and the interactive whiteboard—by anchoring it with a security cable (not included). Underneath the pen tray, you'll find a lock slot that accommodates a security cable, such as a Kensington® lock.

IMPORTANT

Securing the pen tray can provide theft deterrence for the interactive whiteboard because the screws that secure the interactive whiteboard to the wall are located directly behind the pen tray and cannot be removed without first detaching the pen tray. In effect, when you secure the pen tray, you also secure the interactive whiteboard if the security cable is tight.

To secure the pen tray to the interactive whiteboard

1. Loop the security cable behind the pen tray brackets before you secure them to the wall.
2. Thread the lock end of the cable through the loop end of the cable.
3. Verify that the cable is tight enough that you can't remove the pen tray while the lock is in place, and then install the pen tray.
4. Insert the prong end of the security cable into the lock slot, and then complete the pen tray installation by locking it.

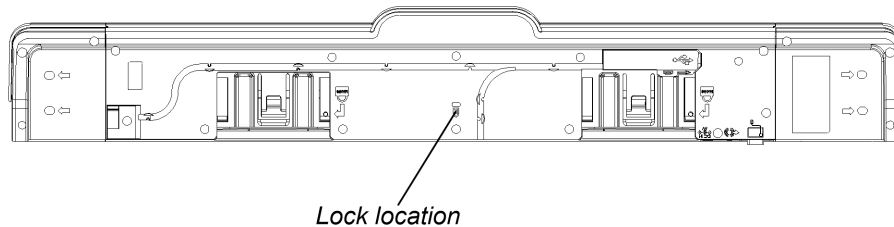

Securing the pen tray to the brackets

Because you can remove the pen tray without tools, you might want to securely attach it to its brackets.

To secure the pen tray to the brackets

Insert two No. 8/M4 screws (not included) into the holes indicated by a lock symbol on the bottom of the pen tray.

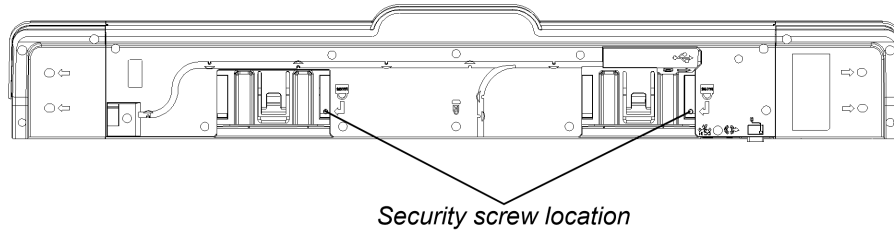

Chapter 3

Setting up the interactive whiteboard

Connecting the interactive whiteboard to the computer	13
Installing SMART Product Drivers	14
Configuring the computer settings	15
Recommended settings	15
Matching the computer's resolution to the projector's resolution	16
Calibrating the interactive whiteboard	16
Orienting the interactive whiteboard	17
Connecting a guest laptop	19

The interactive whiteboard will be touch sensitive after you install SMART Product Drivers on the connected computer. Perform the brief calibration and user orientation procedures (page 16) to ensure the interactive whiteboard interprets the location of your touch accurately.

Connecting the interactive whiteboard to the computer

The interactive whiteboard has a USB 2.0 peripheral interface that runs at speeds of up to 12 Mbps. The unit works with full-speed USB 2.0- and USB 1.1-compliant interfaces. The interactive whiteboard's main USB connection, a USB Type-B receptacle, is located on the bottom of the pen tray. This location provides access to the USB receptacle without having to remove the interactive whiteboard from the wall.

Connect the interactive whiteboard and the computer using the included 16' 5" (5 m) USB cable.



WARNING

For operating safety and to prevent damage to the interactive whiteboard, connect its USB connector, or SMART connection extenders, only to a computer that has a USB compliant interface and that bears the USB logo. In addition, the USB source computer must be compliant with CSA/UL/EN 60950 and bear the CE mark and CSA and/or UL marks for CSA/UL 60950.

- Consult the installation document included with the product for instructions on how to install, connect and secure the interactive whiteboard.

After the interactive whiteboard is installed and connected to your computer, you can install SMART Product Drivers.

Installing SMART Product Drivers

After you install SMART Product Drivers on the computer, the SMART Board interactive whiteboard's surface will respond to the touch of your finger or a pen tray pen.

SMART Product Drivers includes the tools you need to control computer applications with your finger or a pen, and to write over them in digital ink.

NOTE

If you don't install SMART Product Drivers, interactive whiteboard tools such as the pens and the eraser don't work, but you can move the mouse pointer and perform mouse functions by touching the interactive surface.

■ To install SMART Product Drivers

1. Download the **SMART Product Drivers.exe** (Windows® computers) or **SMART Product Drivers.dmg** (Mac computers) file to the computer from the disc or link included with the interactive whiteboard or from smarttech.com/downloads.

NOTE

In most cases, SMART Product Drivers is downloaded and installed automatically when you install SMART Notebook® or SMART Meeting Pro® software.

2. If necessary, turn on the projector to see the projected computer image on the interactive whiteboard.
3. Locate the installation program and follow the on-screen instructions to complete the installation.

SMART System Menu opens automatically.

4. If SMART System Menu doesn't open:
 - On a Windows 7 computer, select **Start > All Programs > SMART Technologies > SMART System Menu**.
 - On a Windows 8 computer, go to the *Apps* screen, and then scroll to and select **SMART Technologies > SMART System Menu**.
 - On a Windows 10 computer, select **Start > All apps**, and then scroll to and select **SMART Technologies > SMART System Menu**.
 - If you have a Mac computer, open **Mac HD**, and then select **Applications > SMART Product Drivers > SMART Board Tools.app**.

The Ready light in the interactive whiteboard's pen tray turns from flashing green to solid green and the SMART Board icon appears in the Windows notification area or Mac Dock, indicating that the interactive whiteboard is communicating successfully with SMART Product Drivers.

You can now pick up a pen from the pen tray and write over the desktop or any projected application, and use all the other features of the SMART software. For more information on using SMART software, press the SMART Board icon, and then select **Help**.

Configuring the computer settings

For optimal configuration, use the following settings for the computer connected to the interactive whiteboard.

Recommended settings

Configure the computer's power management settings to turn off the monitor after one hour of inactivity and to put the hard disks into standby mode after two hours. This extended period prevents the computer from shutting down unexpectedly (for example, during presentations or meetings that have gaps in computer activity).

The computer will stop sending a video signal to the projector after a period of idle time, which may trigger the projector to go into standby mode. Similarly, you can put the projector in standby mode by following the manufacturer's instructions included with the projector. To change the settings, see the instructions included with your computer's operating system.

Matching the computer's resolution to the projector's resolution

Ensure that the resolution settings for the projector and computer match. If the computer's resolution doesn't match the projector's native resolution, the image won't appear correctly or will be distorted. Determine the projector's native resolution, indicated in the projector's user's guide, and then set the computer's resolution to match. You can change the computer's resolution in Windows Control Panel or in the Mac System Preferences. If you need further help changing the computer's resolution, see the instructions included with your computer's operating system.

See *Getting the Best Image Quality on Your SMART Board Interactive Whiteboard* (smarttech.com/kb/127199) for more information.

You might also need to adjust the computer's refresh rate to obtain the best results. Set the computer to an initial refresh rate of 60 Hz, and then adjust this rate up or down until you determine the ideal refresh rate. For more information on changing the computer's refresh rate, see the instructions included with your computer's operating system.

Calibrating the interactive whiteboard

Digital cameras in the corners of the interactive whiteboard track the position of the pens, eraser and your finger on the interactive surface, and then send the information to the SMART software. SMART software interprets this information as mouse clicks, digital ink or ink removal in the appropriate location.

The first time you connect the interactive whiteboard, you should see a pop-up bubble telling you to calibrate the interactive whiteboard. If you don't, press the **Help** button on the pen tray to start the calibration process as described below. This process ensures that the cameras accurately track your finger and the pens on the interactive surface.



IMPORTANT

If you have not used the interactive whiteboard before, you must perform a calibration. If the system detects incorrect calibration parameters, a warning bubble may also appear recommending that you perform a calibration.

To calibrate the interactive whiteboard

1. Click the SMART Board icon in the Windows notification area or Mac Dock, and then click SMART Settings.
2. Select **SMART Hardware Settings**.

3. If you have more than one SMART product connected, select the appropriate interactive whiteboard.
4. Click **Advanced Settings**, and then click **Calibrate**.

The *Calibration* window opens. This can take a few moments while the system sets up.

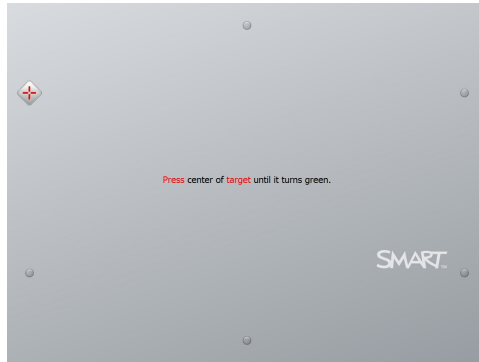

5. Use the tip of a pen tray pen to press the red targets as they appear. Move the tip to the center of each target until the target turns green, and then lift the pen. When you remove the pen, the target moves to the next calibration point.

**NOTE**

You can re-calibrate a target by pressing the left arrow key on the keyboard, or the **Keyboard** or **Right-click** buttons on the pen tray.

6. Continue until you have pressed all the targets.

When you've pressed all the targets, a message appears saying that the calibration was successful, and then the orientation screen appears.

Orienting the interactive whiteboard

After you install SMART Product Drivers on the computer and calibrate the interactive whiteboard, an orientation screen appears. The 4-point orientation process ensures that the calibration coordinates are accurately associated with the relative location of the projected image on the interactive surface. The orientation data is saved in the interactive whiteboard. If you connect a different computer, the orientation data for the interactive whiteboard remains unchanged.

Orient the interactive whiteboard if the projector or interactive whiteboard has moved since you last used it, or whenever the mouse pointer isn't properly aligned with your finger or a pen tray pen when you touch the interactive whiteboard's surface.

To orient the interactive whiteboard

1. Press the **Orientation** button on the pen tray (see *Power module buttons and indicators* on page 22).
The orientation screen appears.
2. Pick up a pen from the pen tray.
3. Beginning at the upper-left corner of the screen, touch the center of the target firmly with the tip of the pen. When you remove the pen, the target moves to the next orientation point. Try not to flick the pen when you lift it from the interactive surface, and make sure that you lift it from the screen at a 90° angle.



NOTE

Although you can use your finger to orient your interactive whiteboard, a fine-point tool such as a pen tray pen provides greater precision when touching the targets. The more precisely you touch the targets, the more accurately your finger or pen tray pen appears on the interactive screen.



Good orientation point

The pen touches the center of the target



Poor orientation point

4. Repeat step 3 until you complete the orientation process.

The orientation screen closes.

NOTE

You can re-orient a target by pressing the left arrow key on your keyboard, or the **Keyboard** or **Right-click** buttons on the pen tray.

Connecting a guest laptop

If you want to connect a guest laptop without installing SMART Product Drivers on it, disconnect the USB cable from the resident computer, and then connect it to the laptop. You'll immediately have touch control of the interactive whiteboard, but won't be able to use digital ink. You'll also need to connect a video cable between the laptop and projector.

 **NOTE**

With a laptop connected, the Ready light on your interactive whiteboard flashes until you install SMART Product Drivers. This is normal. See *Power module buttons and indicators* on page 22 for more information about Ready light states.

You must also install SMART Product Drivers (refer to page 14) on your laptop if you want to use all the features of the interactive whiteboard.

Chapter 4

Using and maintaining the interactive whiteboard

Getting started	22
Turning the interactive whiteboard on and off	22
Power module buttons and indicators	22
Power button	23
Orientation button	23
Help button	23
Ready light	23
Using the Extended Control Panel (SB880E and SB885E only)	24
Using the pen tray	26
Pen tray buttons	26
Customizing the pen tray buttons	26
Using Ink Aware	27
Writing, selecting and erasing using object awareness	27
Using Lockable Pen mode	28
Using gestures	28
Single-finger gestures	29
Selecting and deselecting an object (clicking)	29
Displaying menu options (right-clicking or control-clicking)	30
Dragging an object, scroll bar or window	30
Double-clicking	30
Displaying the next and previous page	30
Multi-finger gestures	31
Displaying menu options (right-clicking or control-clicking)	31
Enlarging an area or object	31
Reducing the scale of an object	31
Scrolling horizontally or vertically	31
Swiping to a different page	32
Rotating an object	32
Erasing digital ink	32
Multitouch gestures	33
Best practices for gestures and tools	33
Tips for trouble-free performance	35

Safety tips for teachers	36
Preventing damage to the interactive whiteboard	36
Keeping the writing surface clean	37
Cleaning the pen tray	37

Getting started

Once you install the SMART Board interactive whiteboard and software and complete the calibration and orientation, you can use the interactive whiteboard to write, erase and move objects, open applications, use Ink Aware programs and save your notes on the computer.

Turning the interactive whiteboard on and off

To start the interactive whiteboard, turn on the computer, turn on the projector, and then press the **Power** button, which is the green light on the left side of the pen tray.

Each time you turn on the interactive whiteboard, the pen color buttons cycle twice, and then the light comes on only for the ink color you select.

When your computer is on and the Power button is off, the interactive whiteboard is in Standby mode. Press the **Power** button to wake up the interactive whiteboard. When you finish, press the **Power** button again to return it to Standby mode.

Power module buttons and indicators

 **NOTE**

The SB880E and SB885E interactive whiteboards feature an Extended Control Panel in place of the power module. See *Using the Extended Control Panel (SB880E and SB885E only)* on page 24

The Power module at the pen tray's left side has Power, Orientation and Help buttons, as well as the Ready light.

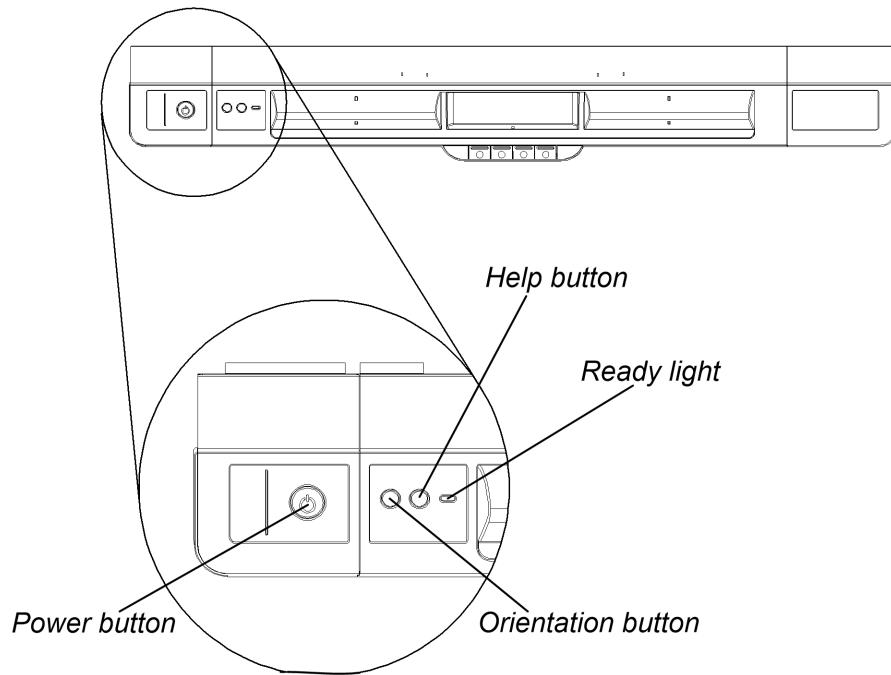

Power button

Press this button to put your interactive whiteboard into Standby mode when it isn't in use, or to restore full power to it when you need to use it. Ensure that the interactive whiteboard is connected to your computer and to a wall power outlet.

Orientation button

Press this button to start the orientation process. Orienting your interactive whiteboard ensures that the mouse pointer or digital ink appears directly below your finger or pen tray tool when you touch the interactive surface. Refer to page 17 for information on performing an orientation procedure.

Help button

Press this button to access on-screen Help options, including links to online Help files, troubleshooting options and contact information for SMART Support.

Ready light

This light indicates the status of the interactive whiteboard's controller module. The Ready light is solid green when the system is working properly.

The following table shows the Ready light's normal states.

Ready Light State	Meaning
Solid red	Your interactive whiteboard is receiving power from the power cable, but isn't communicating with a computer.
Flashing green	Your interactive whiteboard is receiving power and is communicating successfully with your computer's USB HID driver. SMART Product Drivers isn't installed.
	 NOTE In HID mode, interactive whiteboard tools such as the pens and the eraser don't work, but you can move the mouse pointer and perform mouse functions by touching the interactive surface. The Right-click button on the pen tray might work, depending on the version of operating system you're using. Neither the Keyboard nor the Help button work in HID mode.
Solid green	Your interactive whiteboard is receiving power and is communicating successfully with SMART Product Drivers.
Flashing amber	The controller module is in a service mode or the firmware is being updated.

Using the Extended Control Panel (SB880E and SB885E only)

The SB880E and SB885E interactive whiteboards feature an Extended Control Panel (ECP). The ECP gives you control of the interactive whiteboards's basic operations. Press the **Power**  button on the ECP to put the projector into Standby mode or to turn it on. Press the ECP's **Input** button to switch sources on the projector.

IMPORTANT

Do not disconnect cables from the ECP to connect peripheral devices because you could disconnect controls for the interactive whiteboard.

The following diagram and table describe the components of the Extended Control Panel.

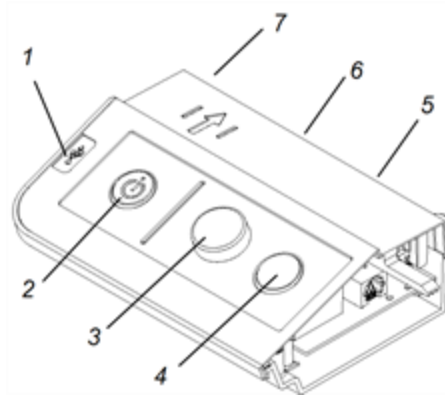

Number	Function
--------	----------

Left side

1	USB A receptacle (for USB drives)
---	-----------------------------------



NOTE

USB drives that you connect to this receptacle are accessible only to the room computer (the computer connected to the USB1 receptacle).

Front

2	Power  button and status indicator light
---	---

3	Volume control
---	----------------

4	Input selection
---	-----------------

Back

5	Two mini USB B receptacles (connect to room computer and laptop)
---	--

6	11-pin connector (connects to ECP cable harness)
---	--

7	4-pin connector (for optional room control)
---	---



NOTE

Use an 800 series control cable (Part No. SBX8-CTRL) to convert the 4-pin connector to a DB9F RS-232 connector for use with a third-party room control system. You can purchase an SBX8 series control cable from your local SMART reseller.

Using the pen tray

In addition to providing a convenient place to hold the pens and the eraser, the pen tray on the SMART Board 800 series interactive whiteboard has several controls, sensors and indicators.

Pen tray buttons

In the center of the pen tray, there are six buttons. The middle four change the color of digital ink for the two pen tools. The buttons on either side of the pen color buttons default to the on-screen keyboard (left button) and right-click (right button) functions.

You can customize the pen, eraser and button settings. For example, you can change line transparency, color and style; you can change the width of the eraser; and you can change the Keyboard and Right-Click button settings so that they perform another action.

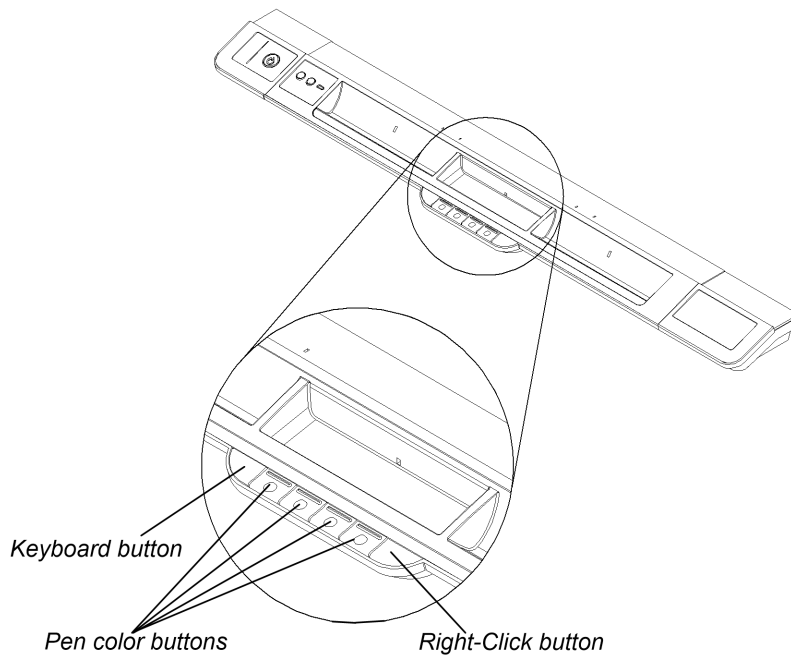

NOTE

Pressing the **Keyboard** and **Right-Click** buttons simultaneously starts the orientation.

Customizing the pen tray buttons

You can use the SMART control panel to customize the SMART hardware settings, including the pen, eraser and button settings.

To customize the button settings

1. Press the SMART Board icon in the Windows notification area or Mac Dock, and then select **SMART Settings**.
SMART Settings opens.
2. Press **SMART Hardware Settings** and select the SMART Board interactive whiteboard.
3. Press **Pen and Button Settings** from the drop-down list, and then select the button you want to customize.
4. Follow the on-screen instructions.

For more information about customizing the settings, open the online Help by pressing the **Help** button on the pen tray, selecting **Help Center**, and then selecting **SMART Hardware Settings**.

Using Ink Aware

Ink Aware integrates SMART software with applications such as Microsoft® Word, Excel® and PowerPoint®. When you use an application that is Ink Aware, whatever you write or draw on your interactive whiteboard is embedded within the file, rather than remaining as an external note created over the file.

To view a list of Ink Aware applications

1. Open the SMART control panel.
2. Press **Configure SMART Tools**.
3. Select **Ink Aware Program Settings**.

The *Aware* dialog box appears. You can enable or disable Ink Aware for any of the applications in the list.

Writing, selecting and erasing using object awareness

The SMART Board 800 series interactive whiteboard features object awareness, which means you can pick up a pen and write, select or erase without replacing the pen. SMART software interprets your intent when you press the interactive surface, based on both the type of tool you're using and the size of the contact area.

- If you touch the interactive surface with the pen, SMART software identifies its reflective surface, and you write or draw in digital ink on the screen.

- If you touch the interactive surface with your finger, you perform a left click.
- If you touch the interactive surface with an eraser, your palm or the side of your hand, SMART software identifies a large contact area, and you erase digital ink from the screen.

Using Lockable Pen mode

If you want every touch on the interactive whiteboard surface to register as a specific tool—such as a pen, eraser, or Select tool—activate that tool and then, hold down a pen color button on the pen tray until its light flashes (about three seconds). The interactive whiteboard locks into that mode.

EXAMPLE

If you want every touch to create red ink, press the red pen tray button until the red light flashes (about three seconds). Then every time you touch the board with your fingers, a pen or an eraser, you create red ink.

NOTE

The selected pen tray light blinks to indicate you're in Lockable Pen mode. To unlock the pen, press any pen tray color button.

Using gestures

Touch gestures enable you to use pre-determined commands without using the keyboard or mouse. With a series of touches on the interactive whiteboard screen, you can navigate pages, change the look of an object, erase digital ink and more.

Before you use gestures, you must enable the interactive whiteboard to recognize them. If you don't enable gestures, only single-finger gestures are enabled.

NOTES

- Gestures are enabled by default on Windows 7 or later operating systems and Mac 10.6 or later operating system software.

- If gestures aren't working as expected on your Windows computer, try the following (consult the documentation for your computer's operating system for details about completing these actions):
 - In the Windows Control Panel, select **Pen and Touch** and disable the Windows Flick and Single-Finger Pan gestures to improve the performance of other gestures. For more information, see the Microsoft website.
 - From the Windows Control Panel, select **Administrative Tools > Services** and ensure that the Tablet PC Input Service is running and starts automatically.
 - In the Windows Device manager, select **Human Interface Devices**. If SMART Virtual Tablet PC driver (one of the SMART Product Drivers) isn't visible, remove SMART Product Drivers and then install them again.
- Depending on the operating system and the specific application you're using, some gestures might not work or could perform differently than described (see smarttech.com/kb/144789).

Single-finger gestures

When you install SMART software, you can perform some gestures using one finger, including selecting objects and double-clicking.

You can also enable "flicks" on Windows 7 later or operating systems. To perform a flick, press the screen, and then drag quickly in one direction before releasing your finger. Flicks perform different actions depending on the direction of the flick, and you can customize flicks to perform different functions.

For more information about flicks, see the Microsoft website.

Single-finger gestures include the following:

Selecting and deselecting an object (clicking)

Quickly press and release the interactive surface to select or deselect an object or option. This performs a standard mouse click.

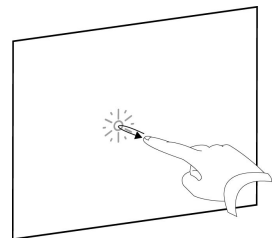

NOTE

This gesture starts programs if the operating system is set to start applications with a single click.

Displaying menu options (right-clicking or control-clicking)

Press and hold the screen with your finger.

In SMART Notebook software, SMART Meeting Pro software, Windows and Microsoft Office programs, the right-click menu appears.

In Mac operating system software, menu options appear.

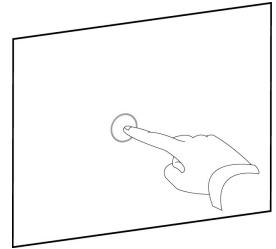

Dragging an object, scroll bar or window

Press and hold an object or scroll bar on the screen. Keep your finger on the screen and slowly move the object or scroll bar. When you reach the position you want, release your finger.

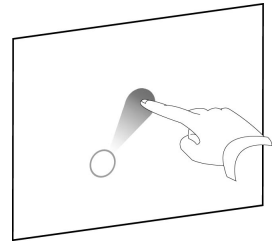

Double-clicking

Quickly press and release the interactive surface twice in the same spot. This performs a standard double-click.

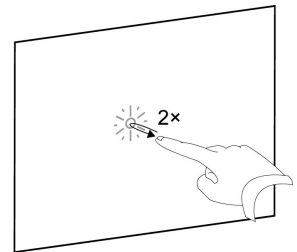

NOTE

This gesture starts programs if the operating system is set to start applications on a double click.

Displaying the next and previous page

To display the next page, press the screen and then quickly press again directly to the right of that point.

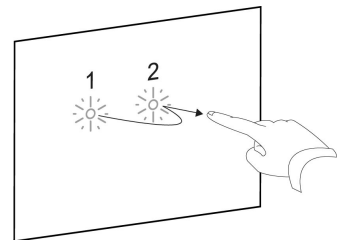

To display the previous page, press the screen and then quickly press again directly to the left of that point.

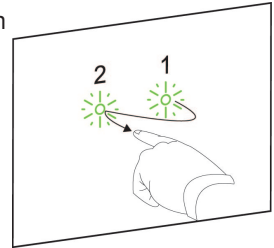

Multi-finger gestures

You can perform some gestures using two or more fingers, including scaling, scrolling and manipulating objects. Multi-finger gestures include the following:

Displaying menu options (right-clicking or control-clicking)

Using two fingers on the same hand, press and hold the screen with one finger and then to press the screen directly to the right of that point with a second finger.

Lift the first finger from the screen, and then select a menu item with any finger.

Enlarging an area or object

Use one finger on each hand to press in the center of the area or object, and then drag your fingers away from each other.

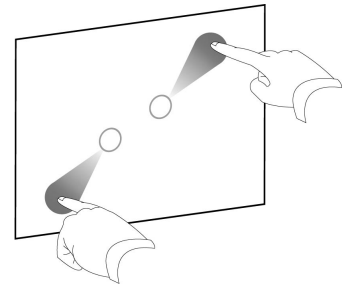

Reducing the scale of an object

Use one finger on each hand to press the screen at opposite ends of the area or object, and then drag your fingers toward each other.

This gesture either scales a single object or the entire page, depending on the application.

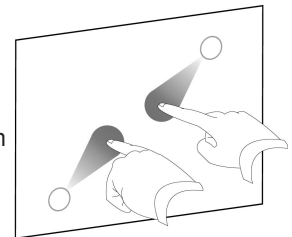

Scrolling horizontally or vertically

Using two fingers on the same hand, press and hold the screen. Keeping your fingers on the screen, move up, down, left or right on the page. Release your fingers when you're satisfied with the view.

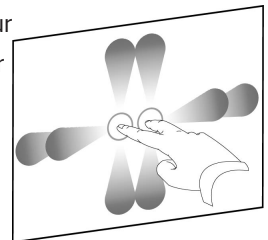

Swiping to a different page

Press the screen with all four fingers on your hand, swipe your fingers to the right to display the previous page or to the left to display the next page, and then release your fingers.

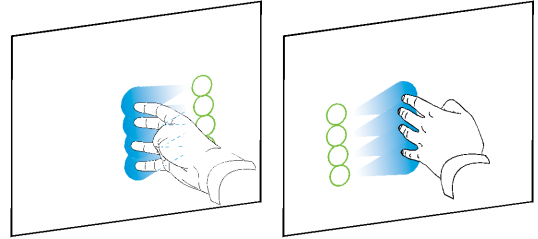

Rotating an object

Place one finger on either side of the object you want to rotate. Keep one finger stationary, and quickly move your second finger around the object. Release your fingers from the screen when you're satisfied with the angle.

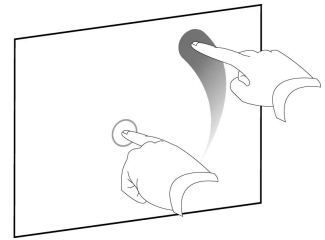

Erasing digital ink

Using your flattened hand, palm, or fist, press the interactive surface and move your hand across the area you want to erase.

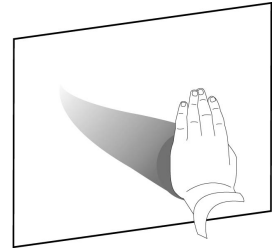

Use a scrubbing motion to erase entire areas of digital ink.

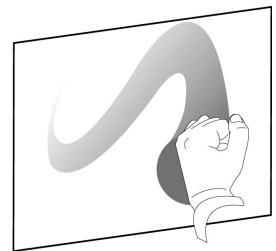

To erase a large area of ink, move your hand in a circle around the area you want to erase, and then swipe your hand across the middle of the circle.

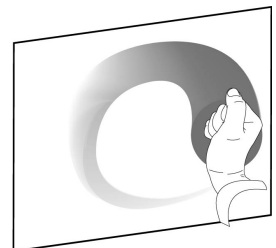

Multitouch gestures

Two people can work together to draw, erase or interact with content anywhere on the interactive surface at the same time.

You can use multitouch hand and finger gestures to toss, rotate or zoom in or out on objects and interact within SMART software.

NOTE

Depending on the operating system and application you're using, some gestures may not work or may perform differently than described. Windows 7 operating system and OS X 10.6 operating system software are multitouch operating systems.

Best practices for gestures and tools

Follow these guidelines when you use gestures and tools with the interactive product.

Hold your fingers perpendicular (90°) to the interactive surface at the contact point.

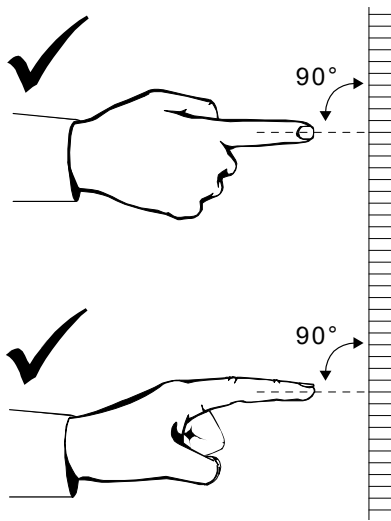

Keep your thumb and other fingers away from the interactive surface. They can generate unintentional commands.

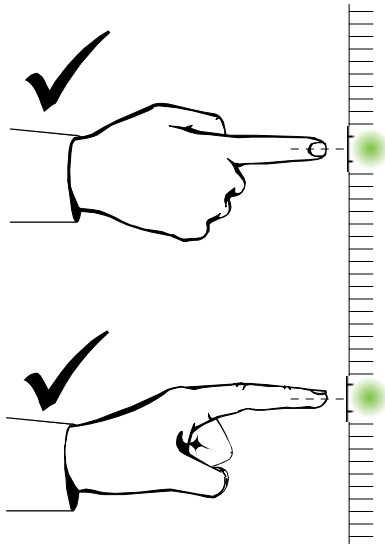

Keep your other hand, elbows and loose clothing away from the interactive surface. They can generate unintentional commands.

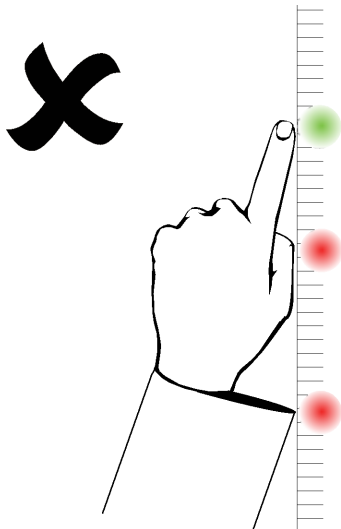

For “click” commands, quickly tap your finger on the interactive surface. Also, make sure you lift your finger far enough away from the interactive surface between presses so that your finger is out of the interactive whiteboard cameras’ view.

For “erase” commands, use your palm or the bottom of your fist.

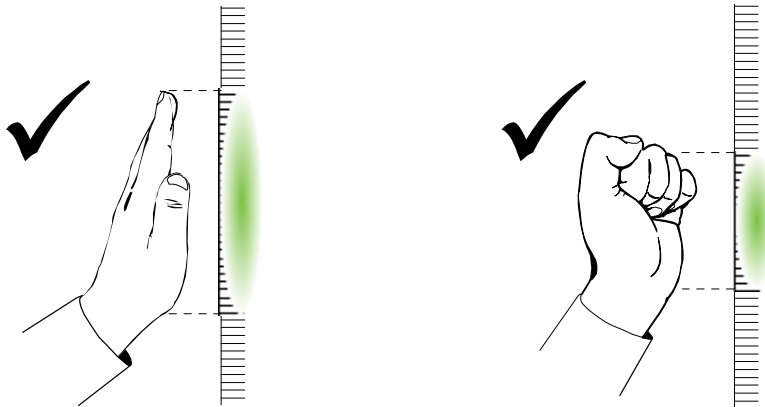

When using the pen tray’s eraser, use the wide surface for large areas and the smaller, angled surface for smaller areas. Don’t use the edge of the eraser because this could be interpreted incorrectly.

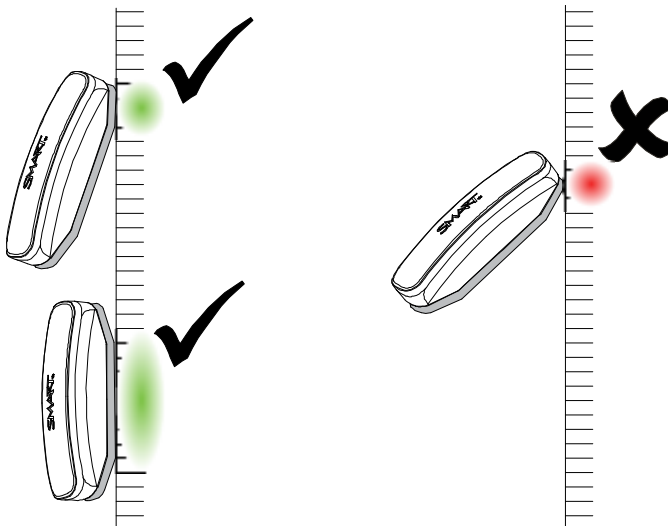

Tips for trouble-free performance

- Connect the interactive whiteboard to a USB interface that’s recognized by the operating system.

- Don't obstruct the cameras' view of the interactive whiteboard's surface or edges. For example, don't place magnets, stickers or adhesive tape on the interactive surface or rest any objects, including the pens, in the recess at the bottom of the interactive surface. This interferes with the corner cameras' ability to detect your finger or pen tray tools.

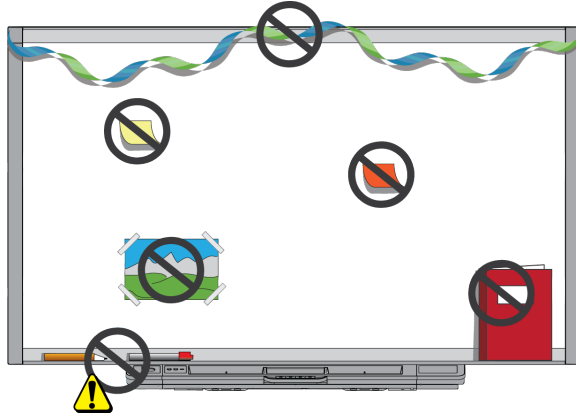

Safety tips for teachers

- Tell students not to look directly at the light beam from the projector. Instead, encourage them to keep their backs to the projector when working at the interactive whiteboard. Before students turn to face the class, they should take a step sideways, out of the projector's beam.
- Make sure that you don't look directly into the projector's beam. Keep your back to the class when you write over a projected image. Step to the side of the interactive whiteboard before you turn to face the class.
- Tell students not to touch the projector because it can become extremely hot during normal operation.
- Don't use a chair to increase a student's reach. If your students can't reach the top of the interactive whiteboard, you might need to remount a wall-mounted unit at a lower position.

Preventing damage to the interactive whiteboard

Although the SMART Board interactive whiteboard's surface is very durable, take the following precautions to prevent damage to the interactive surface and other components.

- Don't set up and use the interactive whiteboard in an area with high levels of dust, humidity or smoke.
- Don't use sharp or pointed objects, such as ballpoint pens or pointers, as writing tools.
- Replace the pen nib when the nib wears out.

- Don't use low-odor dry-erase markers because they can be very difficult to erase. Use standard (high-odor) dry-erase markers that show a warning to use them only in well-ventilated areas.
- Don't use adhesive tape on the interactive surface.
- Don't use abrasive erasers or harsh chemicals to clean your product.
- Don't use compressed air to clean the interactive whiteboard's cameras. The force of the air could damage them.

Keeping the writing surface clean

With proper care, the SMART Board interactive whiteboard will provide years of trouble-free service. Follow these tips to keep the interactive whiteboard's surface clean:

- Don't spray cleaner directly onto the interactive whiteboard's surface. Instead, spray a light amount of cleaner on a cloth and then gently wipe the interactive surface.
- Clean your interactive whiteboard at least every six months.
- Don't allow excess cleaner to flow onto the frame's reflective surfaces or into the pen tray slots.
- The digital cameras located in the corners of the frame are protected from dust and dirt by windows. In extremely dusty environments, spray an alcohol-free household glass cleaner, such as Windex® cleaner, on a cotton swab and rub it gently on the windows. Don't use compressed air to clean the cameras.



IMPORTANT

- Turn the interactive whiteboard off before you clean it so that you do not scramble the desktop icons or inadvertently activate applications when you wipe the interactive surface.
- To view dirt or streaks more easily, set the projector to standby (lamp off) mode.

Cleaning the pen tray

If the infrared sensors in the sides of the pen tools' slots become obstructed by dirt, moisten a cotton swab with an alcohol-free household glass cleaner, such as Windex, and then carefully clean the infrared transmitter and receiver.

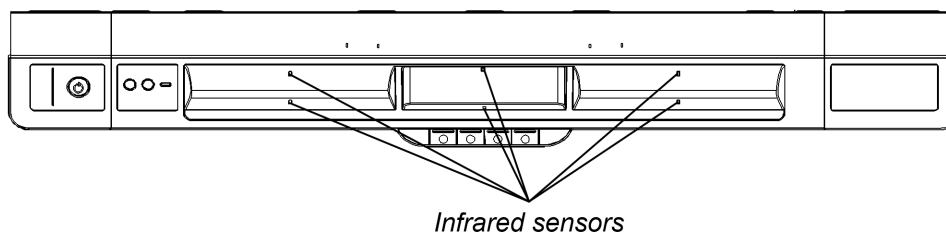

Chapter 5

Troubleshooting the interactive whiteboard

Updating SMART software	39
Adjusting the projected image	40
Resetting the interactive whiteboard	40
Using the Connection Wizard	41
Starting the troubleshooting process	42
Troubleshooting using the Ready light	47
Flowchart 1: Getting started	47
Flowchart 2: The Ready light is off	48
Flowchart 3: The Ready light is solid red	49
Flowchart 4: The Ready light is flashing green	49
Flowchart 5: The Ready light is solid green but pen tray tools behave unexpectedly	51
Flowchart 6: The Ready light is solid green but the interactive whiteboard isn't responsive ..	52
Troubleshooting using SMART Board diagnostics	53
Checking the camera views	53
Checking the interactive whiteboard's calibration	54
Finding more information	55
Contacting SMART Support	56
Transporting the interactive whiteboard	57
Removing the pen tray	57

Updating SMART software

To update SMART software, go to the SMART software download page or use SMART Product Update (SPU).

To check for software updates

1. Click the SMART software icon in the Windows notification area or the Mac Dock, and then select **Check for Updates and Activation**.

The *SMART Product Update* dialog box appears listing the SMART software products installed on your computer.



NOTE

If you don't see the *Check for Updates and Activation* option, contact the network administrator.

2. Click the **Update** button beside the software you want to update.

The SMART software updates automatically.

Adjusting the projected image

Alignment errors occur when the projected image isn't perpendicular to the screen. Alignment errors can occur when you mount the interactive whiteboard on an uneven surface or a wall that has obstructions, or if you position the projector too far from the vertical or horizontal center of the interactive whiteboard.

If the projector isn't installed in a fixed location, you can correct many image problems by shifting your projector or adjusting its alignment settings and zoom lens.

If you are using a SMART projector, refer to the interactive whiteboard system's user's guide. If you're using an Epson® projector, consult the projector's documentation.



NOTE

Adjust the image size and shape while projecting a full-screen image such as your projector's splash screen, unless the splash screen image is much smaller than the computer's projected image. Before you adjust the projected image, set the computer's resolution and refresh rate (see *Configuring the computer settings* on page 15).

Resetting the interactive whiteboard

If the interactive whiteboard behaves erratically or becomes unresponsive, possibly because of an electrostatic discharge, a power interruption or some other event, you might be able to restore normal operation by resetting the interactive whiteboard. This turns the power off and back on, restarting all the interactive whiteboard's components.

To reset the interactive whiteboard

Disconnect and then connect the power cable at the wall outlet.

OR

Press the **Reset** button briefly (less than three seconds) on the bottom of the pen tray.

All the pen tray indicator lights flash sequentially twice and the interactive whiteboard resets.

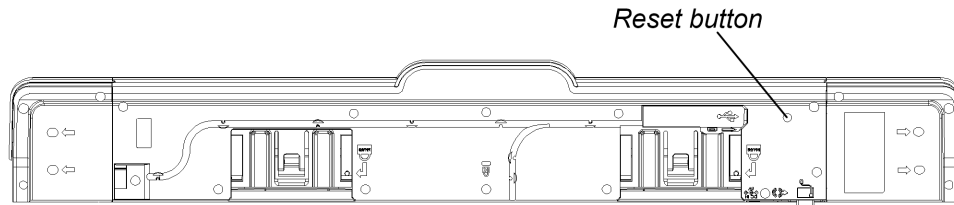

 **IMPORTANT**

If you accidentally press the Reset button for longer than three seconds, the interactive whiteboard goes into a service mode and the pen tray flashes amber. To get the interactive whiteboard out of the service mode, disconnect the power cable from the wall outlet, and then connect it again.

 **NOTE**

The Reset button is recessed so that it can't be triggered accidentally. Use a long, narrow object, such as a ball-point pen, to press this button.

Using the Connection Wizard

You can resolve many issues using the SMART Connection Wizard found in the SMART control panel.

To start the SMART Connection wizard

1. Press the **Help** button on the pen tray.

The *Help and Support for Your SMART Board Interactive Whiteboard* window opens.

2. Press **Connection Wizard**.

The *SMART Connection Wizard* opens.

 **TIP**

You can also access the SMART Connection Wizard by selecting the SMART software icon in the Windows notification area or Mac Dock, selecting **Control Panel**, and then selecting **Connection Wizard**.

3. Select **SMART Board 800 series interactive whiteboard**, and then press **Next**.
4. Select the option that best describes the issue you're encountering, and follow the on-screen instructions to troubleshoot the interactive whiteboard.

Starting the troubleshooting process

The Ready light is on the pen tray's left side beside the Help button. It indicates the status of the controller module.

 **NOTE**

The following illustration shows the pen tray for the SB880 and SB885 model interactive whiteboards. The SB880E and SB885E models feature an Extended Control Panel in place of the power module. See *Using the Extended Control Panel (SB880E and SB885E only)* on page 24

The Ready light is solid green when the system is working properly.

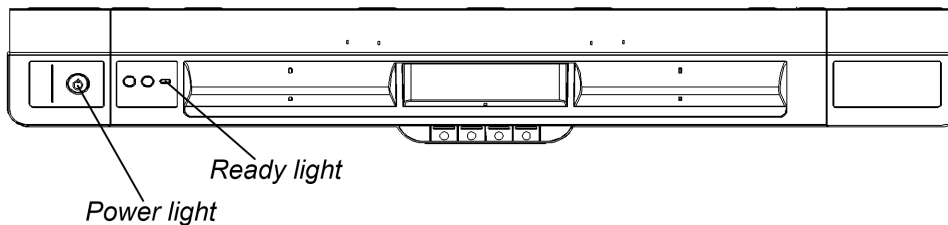

The following table shows the Ready light's normal states.

If the Ready light is...	The interactive whiteboard...	Actions
Off	Isn't receiving power or is in Standby mode.	<ul style="list-style-type: none">• Press the Power button on the pen tray to bring the interactive whiteboard out of Standby mode.• Ensure that the interactive whiteboard is connected to a wall outlet.
Solid green	Is receiving power and is communicating successfully with SMART Product Drivers	
Solid red	Is receiving power from the power cable but isn't communicating successfully with the computer.	<ul style="list-style-type: none">• Ensure that the power cable is connected properly to the interactive whiteboard.• Ensure that the interactive whiteboard is connected properly to the computer using a USB cable.• Ensure that the computer is on.

If the Ready light is...	The interactive whiteboard...	Actions
Flashing green	<ul style="list-style-type: none">• Is in HID mode. It's receiving power and is communicating successfully with the computer's USB HID driver.• SMART Product Drivers isn't installed.	<p>This is normal mouse mode and you might not want to use tools such as the pens and the eraser. You can move the mouse pointer and perform mouse functions by touching the interactive surface. The Right-Click button on the pen tray might work, depending on the operating system you're using. Neither the Keyboard nor the Help button work in HID mode.</p> <ul style="list-style-type: none">• To use the tools, install SMART Product Drivers.• To use all the features of the interactive whiteboard, install SMART software (smarttech.com/software).
Flashing amber	Is in a Service mode or its firmware is being updated.	Wait until the download finishes. After the download is complete, the Ready light turns solid green.

Refer to this table for troubleshooting tips if the Ready light indicates that the interactive whiteboard is working properly, but you're still experiencing problems.

Symptoms	Possible causes	Actions
No image is projected on the interactive whiteboard, or a "No Input" message appears.	The computer is in Standby mode.	Move the mouse or touch the interactive surface or any key on the keyboard to bring the computer out of Standby mode.
	The computer is off.	Turn on the computer (or press your computer's reset button), and then log on as usual.
	The projector isn't receiving a video signal.	<ul style="list-style-type: none"> • Check the video cable connections. • Ensure that the correct video input is selected on the projector. • Ensure that the projector is on and that it's connected to your computer and a wall outlet. • If you're using a laptop computer, turn on the external video connection. Refer to your laptop's user's guide for more information.
The orientation screen doesn't appear when you press the Orientation button.	The orientation screen is appearing on a different display.	Press the Orientation button again, or press SPACEBAR on the keyboard until the orientation screen appears. Alternatively, open SMART Settings and select Orient/Align the SMART Product .
The projected image is blurry, too large or doesn't completely fill the interactive surface.	The projector's position, zoom and focus settings aren't adjusted.	Adjust the projector's position, zoom and focus settings. Refer to the projector's user's guide for more information.
	The computer's display resolution settings don't match the projector's native resolution.	Refer to the projector's user's guide for the correct display resolution, and then go to Windows Control Panel or the Mac System Preferences to change the computer's display resolution to match the projector.

Symptoms	Possible causes	Actions
The SMART Board icon doesn't appear in the notification area (Windows) or dock (Mac).	SMART System Menu isn't running.	<p>Start SMART System Menu.</p> <p>In the Windows 7 operating system, select Start > All Programs > SMART Technologies > SMART System Menu.</p> <p>In the Windows 8 operating system, go to the <i>Apps</i> screen, and then scroll to and select SMART Technologies > SMART System Menu.</p> <p>In the Windows 10 operating system, select Start > All apps, and then scroll to and select SMART Technologies > SMART System Menu.</p> <p>For Mac computers, select Finder > Applications > SMART Technologies > System Menu.</p>
	SMART Product Drivers aren't installed.	Install SMART Product Drivers on the computer (refer to <i>Installing SMART Product Drivers</i> on page 14).
There is a small red × on the SMART Board icon.	SMART Product Drivers is unable to detect the interactive whiteboard.	Ensure that the USB cable is connected to the computer and the interactive whiteboard and that the cable isn't longer than 16' (5 m).
	SMART Board software service isn't running.	Start SMART Board software service.
Touch isn't accurate. The pointer doesn't appear directly below your finger. When you write on the interactive surface, your writing appears at a slight distance from the pen.	The interactive whiteboard isn't oriented properly.	<p>Orient the interactive whiteboard. To start the orientation, press the Orientation button on the pen tray (refer to <i>Orienting the interactive whiteboard</i> on page 17).</p> <p>If the Orientation screen doesn't appear, perform a calibration procedure. Refer to <i>Calibrating the interactive whiteboard</i> on page 16.</p>
Digital ink doesn't appear on the interactive whiteboard or appears intermittently.	The interactive whiteboard isn't calibrated properly.	Use SMART Board Diagnostics to confirm the issue, and then perform a calibration procedure. Refer to <i>Calibrating the interactive whiteboard</i> on page 16.

Symptoms	Possible causes	Actions
Nothing happens when you touch the interactive whiteboard, even though the computer and projector are on.	A camera is obscured.	Remove any objects attached to the interactive surface or resting in the bottom bezel behind the pen tray.
	The interactive whiteboard is off.	Press the Power button on the interactive whiteboard's pen tray to turn it on.
One of the pen color buttons is flashing.	The interactive whiteboard is in Lockable Pen mode.	Press any pen tray button to exit Lockable Pen mode.
Ink always appears on the screen, even when you touch the interactive surface with a finger or the palm of your hand.	A pen is missing from the pen tray and Touch Recognition has been disabled.	Place all the pen tray tools in their slots and press the Help button on the pen tray. Select Touch Recognition Settings and ensure the Enable Touch Recognition box is selected.
	You have selected the lockable pen option.	Press any pen tray color button to exit the lockable pen option.
An error message appears when you try to calibrate the interactive whiteboard.	A camera isn't properly connected or isn't functioning correctly.	Contact SMART Support .

Troubleshooting using the Ready light

You can troubleshoot the interactive whiteboard using the Ready light, together with other observable symptoms and behaviors. Before you start troubleshooting, see *Starting the troubleshooting process* on page 42 to locate the Ready light, and then familiarize yourself with its states during normal operation. The following flowchart directs you to the next stage in the troubleshooting process.

Flowchart 1: Getting started

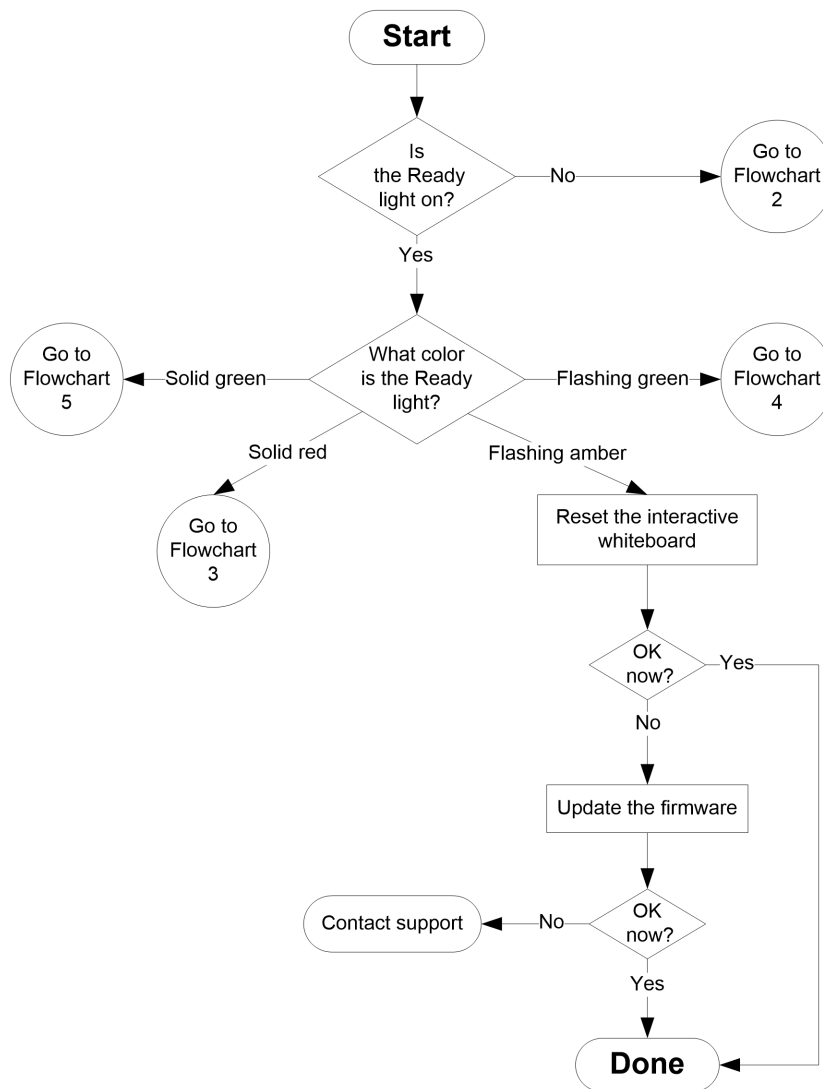

Flowchart 2: The Ready light is off

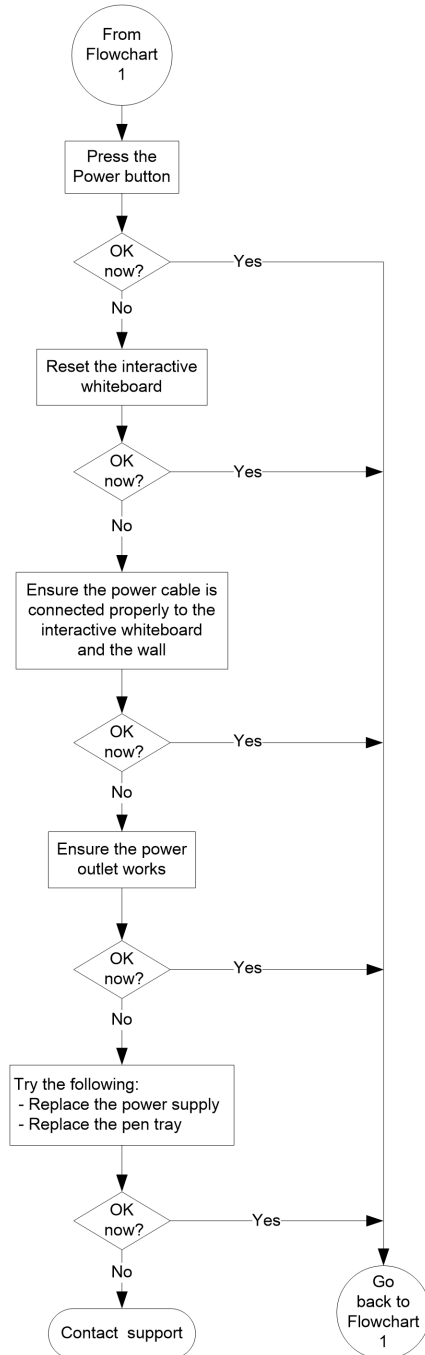

When the Ready light is off, the interactive whiteboard isn't receiving power.

Press the **Reset** button on the bottom of the pen tray to reset the interactive whiteboard. Alternatively, disconnect the power cable at the wall outlet and connect it again.

When you reset the interactive whiteboard, all the pen tray lights flash sequentially twice, indicating successful communication with the SC14 controller. If they flash continuously, reset the interactive whiteboard again. If this doesn't solve the issue, you might need to replace the pen tray.

Check that the power cable is connected to the correct receptacle. The audio and power receptacles are located beside each other on the back of the pen tray.

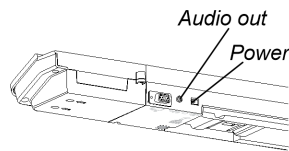

Flowchart 3: The Ready light is solid red

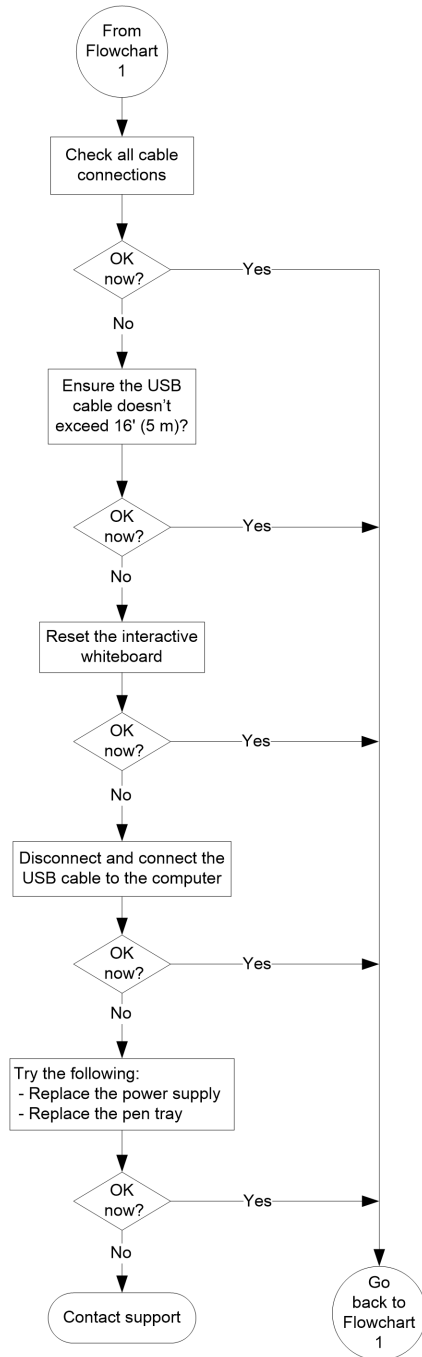

A red Ready light indicates that the interactive whiteboard is receiving power but isn't communicating successfully with the computer. In most cases, pen tray lights don't turn on and the screen doesn't respond to touch.

The interactive whiteboard is connected to the computer with a USB cable, and to the wall outlet with a power cable. You can access these cables by reaching underneath the pen tray.

The USB cable must not exceed 16' (5 m).

Press the **Reset** button on the bottom of the pen tray to reset the interactive whiteboard. Alternatively, disconnect the power cable at the wall outlet, and connect it again.

Flowchart 4: The Ready light is flashing green

This is the normal mouse mode state when SMART Product Drivers isn't installed on the computer. This mode can be useful for occasional or guest users who don't require the use of SMART Board Tools or pen tray functions.

Before you can use SMART Board Tools or the pen tray pens and eraser, SMART Product Drivers must be installed and running. If the SMART software icon doesn't appear in the Windows notification area or Mac Dock, you must start SMART Product Drivers.

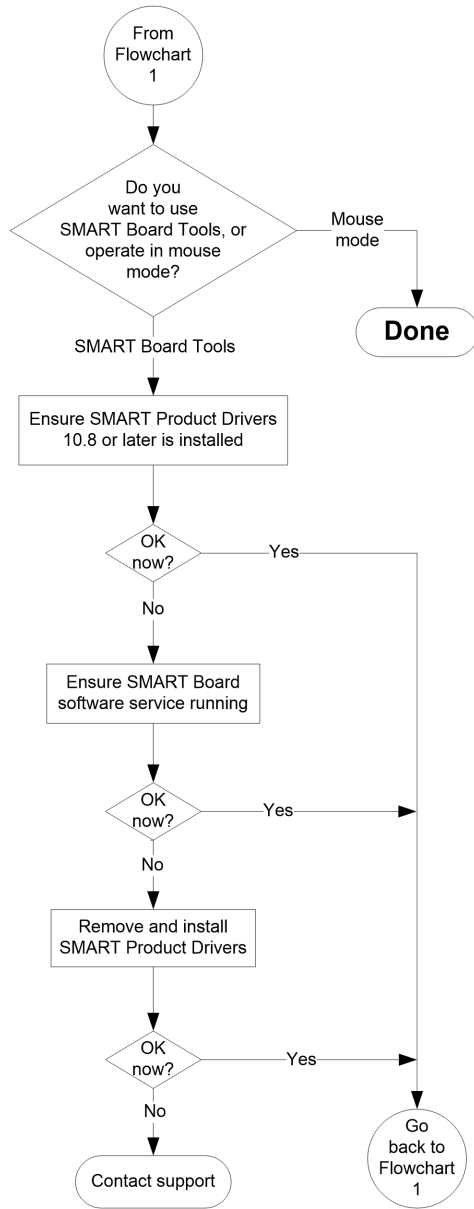

To use all the features of the SMART Board 800 series interactive whiteboard, go to smarttech.com/downloads to download SMART software and install it on your computer.

To determine whether the SMART Board software service is running, open the SMART control panel and check the message that appears at the bottom. Start SMART Board software service.

Flowchart 5: The Ready light is solid green but pen tray tools behave unexpectedly

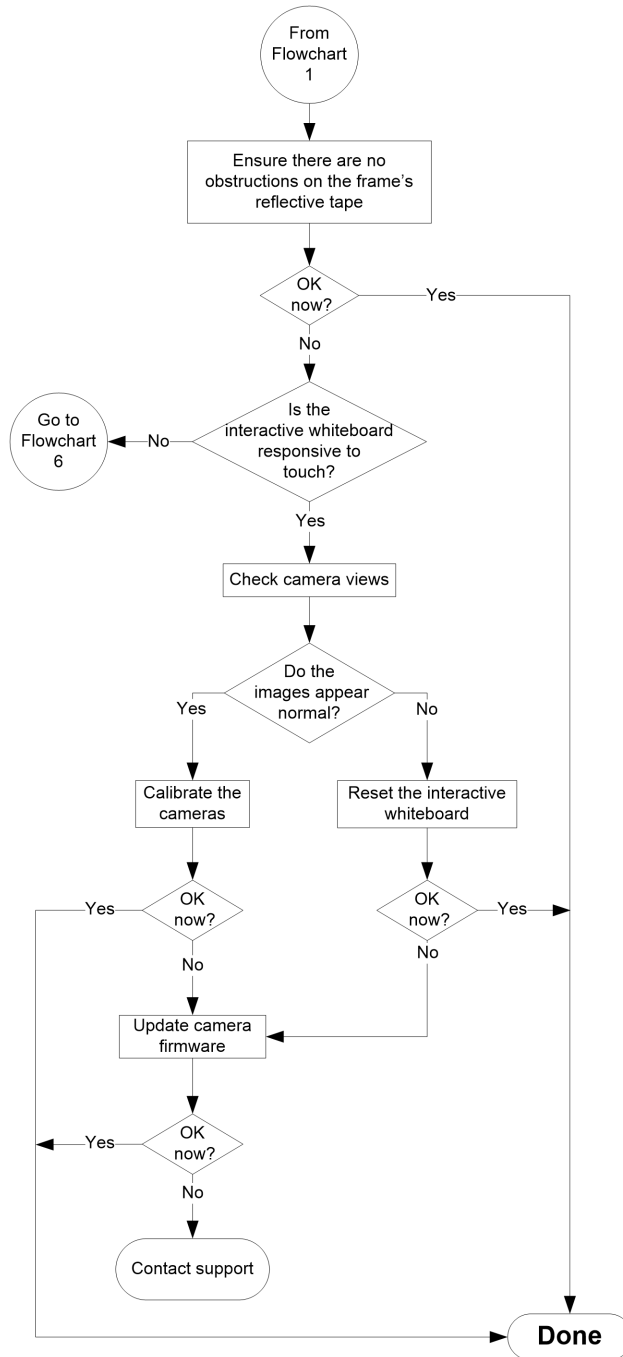

A solid green Ready light indicates that the interactive whiteboard is working properly. However, if the pen tray tools don't work as expected, use this flowchart to troubleshoot the interactive whiteboard.

If another user has reassigned the pen, eraser or button functions, the tools might not work as expected. You can return them to normal operation using the SMART control panel to change SMART hardware settings.

Use camera views to examine the images reflected to the cameras from the inner edge of the frame and to determine which cameras are faulty (refer to *Checking the camera views* on page 53).

Press the **Reset** button on the bottom of the pen tray to reset the interactive whiteboard. Alternatively, disconnect the power cable at the wall outlet and connect it again.

Calibrate the cameras to ensure that they accurately track your fingers and the pens.

To update the firmware, run the SMART Firmware Update application.

Flowchart 6: The Ready light is solid green but the interactive whiteboard isn't responsive

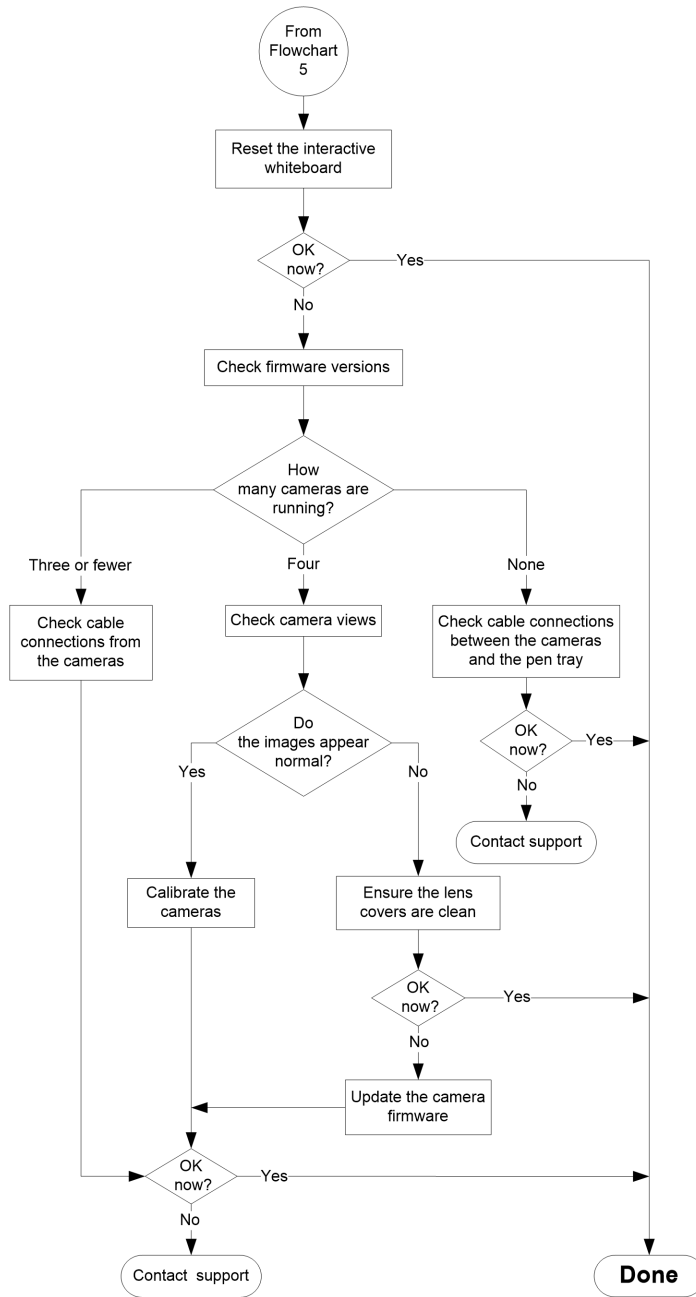

Press the **Reset** button on the bottom of the pen tray to reset the interactive whiteboard. Alternatively, disconnect the power cable at the wall outlet, and connect it again.

To check firmware versions, go to SMART Board Diagnostics and then select **View > SBX800/SBID8070i Bar > Version > Update**. A table appears listing the firmware version currently running in each camera. If a camera isn't operating, you'll see zeros.

Use camera views to examine the images reflected to the cameras from the inner edge of the frame and to determine which cameras are faulty. Refer to *Checking the camera views* on the facing page.

Calibrate the cameras to ensure that they accurately track your fingers and the pens. Refer to *Calibrating the interactive whiteboard* on page 16.

To update the firmware, run the SMART Firmware Update application.

Troubleshooting using SMART Board diagnostics

If you touch the interactive whiteboard's surface and nothing happens, there is no digital ink, or the ink appears in some locations and not in others, use SMART Board Diagnostics to help identify and resolve these issues.



IMPORTANT

Do not change diagnostic settings unless asked to do so by SMART Support.

Checking the camera views

If nothing happens when you touch the interactive whiteboard surface, ensure that nothing is obscuring any of the cameras' views.

To check camera views

1. Press the SMART software icon in the Windows notification area or Mac Dock, and then press **Control Panel**.

The SMART control panel opens.

2. Select **About Software and Product Support > Tools > Diagnostics**.

The *SMART Board Diagnostics* screen opens.

3. Select **View > SBX800/SBID8070i Bar**.

The *SBX800/SBID8070i* bar appears.

4. Click **View**.

The camera view window appears.



NOTE

The bottom-left camera is *Camera 0*, the top-left camera is *Camera 1*, the top-right camera is *Camera 2* and the bottom-right camera is *Camera 3*.

5. Click **Update** to show what each of the four cameras sees. This can take several moments.

Each bar represents a picture from a camera, and the number beside the bar tells you which camera took the corresponding picture. This image shows normal camera views.

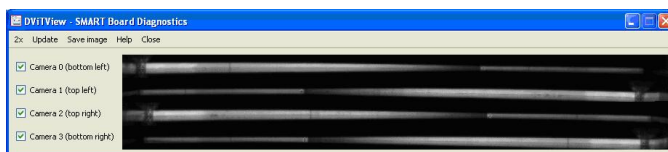

6. If one of the cameras' views remains black, the camera is obstructed or can't locate the reflective surface on the interactive whiteboard inner frame. This image is an example of a camera view obscured by a pen or other object.



Check the camera lens and ensure that nothing is obstructing the view and that nothing is affixed to the interactive surface.

7. Click **Save Image** and then save the file with your choice of file name and location.



TIP

It's a good idea to save the file to the SMART Technologies folder. You can save the image with the log file for future reference or to email to a technical support representative.

Checking the interactive whiteboard's calibration

If no digital ink appears or appears only in certain areas when you write on the interactive whiteboard, the interactive whiteboard could be incorrectly calibrated. You can test the calibration using SMART Board Diagnostics Tracker utility.

To check the interactive whiteboard's calibration

1. Press the SMART software icon in the Windows notification area or Mac Dock, and then press **Control Panel**.

The SMART control panel opens.

2. Select **About Software and Product Support > Tools > Diagnostics**.

The *SMART Board Diagnostics* screen opens.

3. Select **View > SBX800/SBID8070i Bar**.

The *SBX800/SBID8070i* bar appears.

4. Click **Tracker**.

The screen becomes white.

5. Touch the interactive screen with a pen, finger or eraser.

6. Verify that the tracking rays overlap.

This image shows two contact points: a finger and an eraser.

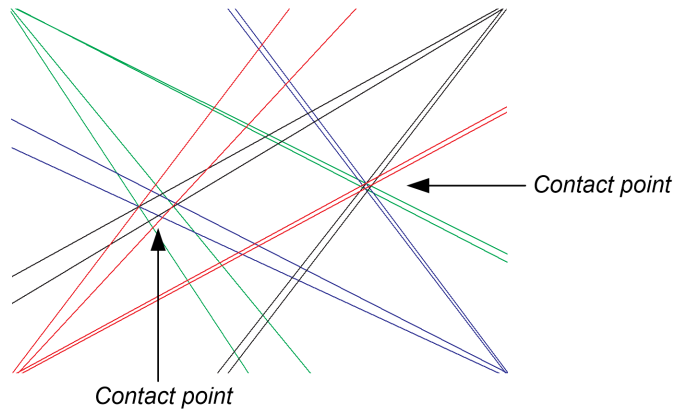

7. If the rays don't overlap, and the rays change from colored to black, calibrate the cameras (see page 16).

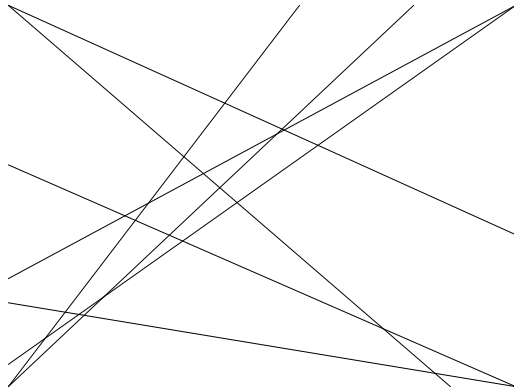

NOTES

- If one or more of the lines don't move or don't appear, a camera is obstructed or isn't working properly.
- If intermittent black lines appear, a second object, such as your sleeve, is touching the screen while you write.

Finding more information

The Help Center contains links to a wide range of information, including procedures, concepts, help with applications, SMART software tool descriptions, troubleshooting hints and more.

Access the Help Center by pressing the **Help** button on the pen tray. The Help button also provides access to the orientation screen and SMART contact information. Alternatively, you can access the Help Center from the SMART software icon in the Windows notification area or Mac Dock.

Contacting SMART Support

SMART Support welcomes your call. However, if you experience difficulty with the SMART Board interactive whiteboard, you might want to contact your local reseller first. Your reseller can often resolve the issue without delay.

You can find a list of parts and service parts diagrams for the interactive whiteboard or interactive whiteboard system on the SMART support website (smarttech.com/support). To order parts, contact your local reseller (smarttech.com/where).

Before contacting SMART Support, make note of the SMART Board interactive whiteboard's serial number. If you printed this manual, you can make note of the serial number in the inside cover of this manual.

To determine the interactive whiteboard's serial number

You can find the serial number in two places: on the back of the SMART Board interactive whiteboard, and on the bottom right-hand edge of the interactive whiteboard's frame (the side).

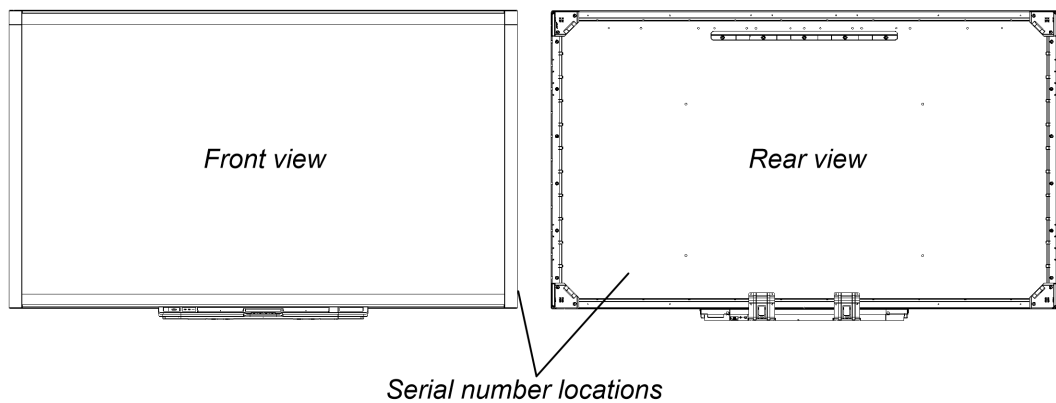

The serial number on the SMART Board interactive whiteboard always begins with the letters SBX, followed by the interactive whiteboard's model number, for example, SBX880-xx-xxxxxx. The serial number can include numbers, letters and hyphens.

 **NOTE**

Make sure you include all the numbers, letters and hyphens in the serial number when contacting technical support.

Transporting the interactive whiteboard

Save the original SMART Board 800 series interactive whiteboard packaging so that it's available if you need to transport the interactive whiteboard. When required, repack it with as much of the original packaging as possible. This packaging was designed to provide the best possible protection against shock and vibration. If the original packaging is no longer available, you can purchase the same packaging directly from your authorized SMART reseller (smarttech.com/where).

If you prefer to use your own packaging materials, make sure you adequately protect the interactive whiteboard. Ship the interactive whiteboard in an upright position to deter shippers from placing heavy objects on it.

Removing the pen tray

It might be necessary to remove the pen tray when you transport or service the interactive whiteboard.

 **CAUTION**

There are no user-serviceable parts inside the pen tray. Do not disassemble the pen tray. If dust or small items become wedged in the spaces around the buttons and prevent them from being pressed or causing constant button contact, remove the obstruction carefully.

 **NOTE**

Electrostatic discharge (ESD) protection isn't required when performing the following procedure.

To remove the pen tray

1. Turn off the interactive whiteboard and disconnect the cables from the pen tray by disconnecting the power cable from the wall outlet and the USB cable from the computer.
2. Remove the pens and the eraser from the pen tray.
3. Reach under the pen tray and disconnect the USB cable.

CHAPTER 5
TROUBLESHOOTING THE INTERACTIVE WHITEBOARD

4. If you secured the pen tray to its brackets using two security screws, remove the screws and set them aside.
5. If you secured the pen tray using a Kensington lock or similar device, unlock and remove the lock.
6. Reach under the pen tray and pull down on the two large plastic clips. Because the ends of these clips project slightly downwards, they're easy to locate.

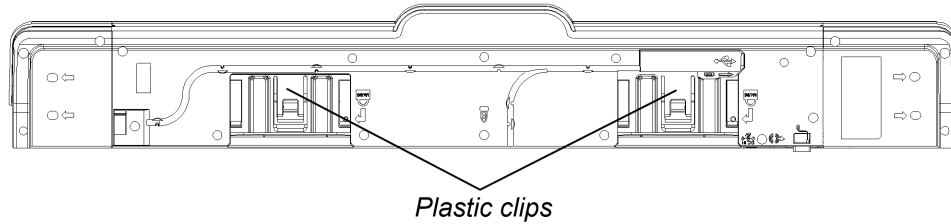

7. While applying downward pressure to the clips, gently slide the pen tray toward you until you can access the cables attached to the back of the pen tray.
8. Carefully disconnect these cables before completely removing the pen tray from the two L-shaped metal brackets.

To reinstall the pen tray, simply reverse these steps. When you replace the pen tray on its supports, you'll hear a click when it slides into place.

Appendix A

Hardware environmental compliance

SMART Technologies supports global efforts to ensure that electronic equipment is manufactured, sold and disposed of in a safe and environmentally friendly manner.

Waste Electrical and Electronic Equipment and Battery regulations (WEEE and Battery Directives)

Electrical and electronic equipment and batteries contain substances that can be harmful to the environment and to human health. The crossed-out wheeled bin symbol indicates that products should be disposed of in the appropriate recycling stream and not as regular waste.



More information

See smarttech.com/compliance for more information.

Index

A

- about the 800 series interactive whiteboard, 1
- accessories, 5-6
- audio
 - controlling volume of, 25

B

- batteries, 59
- buttons
 - customizing, 26
 - flashing, 46
 - Keyboard, 26
 - Right-Click, 26

C

- cables, USB, 13
- calibrating, 16
- cleaning, 37
- components
 - interactive whiteboard, 2
 - other, 4
- configuring the computer, 15
- connecting
 - guest laptop, 19
 - to your computer, 13
 - USB, 13
- connection diagrams
 - ECP, 25
- Connection Wizard, 41

E

- ECP
 - about, 5
 - using, 24
- environmental requirements, 7
- erasing, 27

F

- flowchart
 - 1 - getting started, 47
 - 2 - Ready light off, 48
 - 3 - Ready light red, 49
 - 4 - Ready light flashing green, 49
 - 5 - Ready light green, pen tray problems, 51
 - 6 - Ready light green, no response, 52

G

- gestures
 - best practices, 33
 - multi-finger, 31
 - multitouch, 33
 - single-finger, 29
 - using, 28

H

- highlights, 2
- how it works, 4

I

- image adjusting, 40

INDEX

Important information, i
included, 5
Ink Aware, 27
input selection, 25
installation, 9
installing, 8
installing and securing, 7
installing SMART Product Drivers, 14
interactive whiteboard, 8

L

Locked Ink mode, 46

O

object awareness, 27
optional, 6
orienting, 17

P

pen tray
 cleaning, 37
 customizing buttons, 26
 lights, 22
 power module, 22
 removal, 57
 using, 26
power, 25
preventing damage, 36

R

Ready light, troubleshooting with, 47
Reset button, 40
resetting, 40
room control, 25

S

safety warnings and cautions, i

SBX8-CTRL room control adapter, 25
securing pen tray, 10
security screw location, 11
selecting, 27
software updates, 39

T

tips
 cleaning, 37
 cleaning pen tray, 37
 installation, 9
 preventing damage, 36
 safety, 36
 trouble-free performance, 35
 troubleshooting, 42
transporting, 57
troubleshooting
 checking calibration, 54
 checking camera views, 53
 diagnostics, 53
 interactive whiteboard, 39
 tips, 42
 using Ready light, 47

U

updating software, 39
USB, 13
USB drives, 25
USB receptacles, 25
using
 Connection Wizard, 41
 gestures, 28
 Ink Aware, 27
 Lockable Pen mode, 28
 pen tray, 26
using and maintaining, 21

V

volume control, 25

INDEX

W

WEEE and Battery Directives, 59

weight, ii

writing, 27

SMART TECHNOLOGIES

smarttech.com/support

smarttech.com/contactsupport

smarttech.com/kb/144817